

Nombre :

Curso :

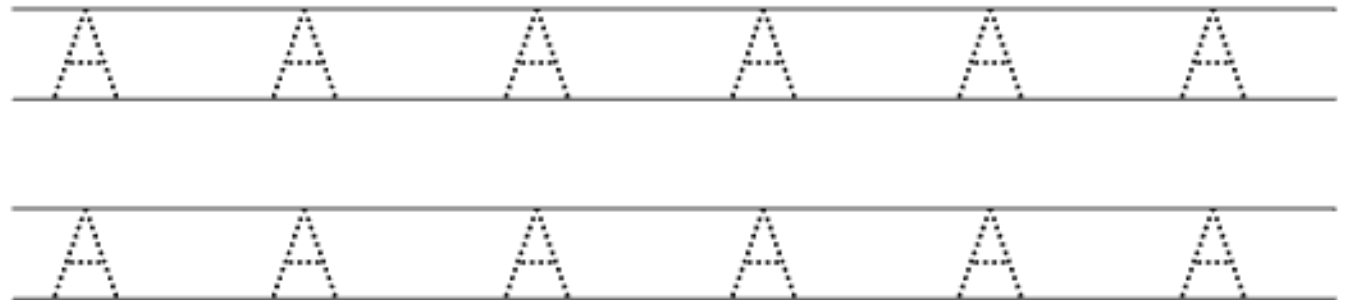
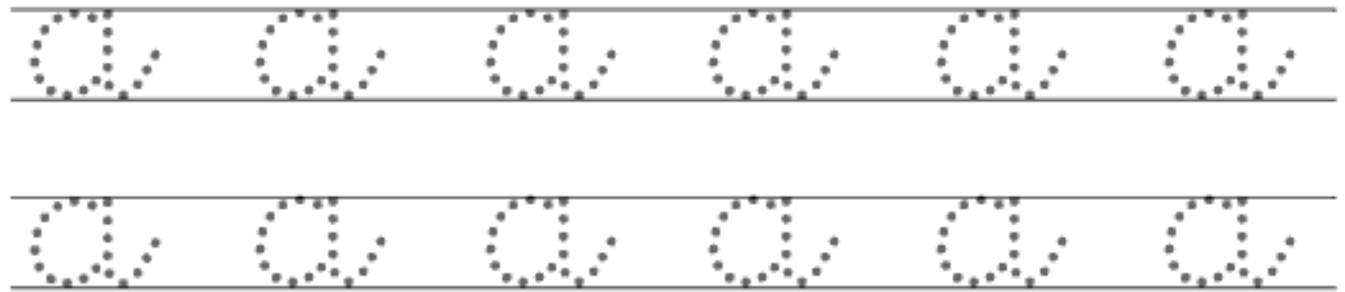
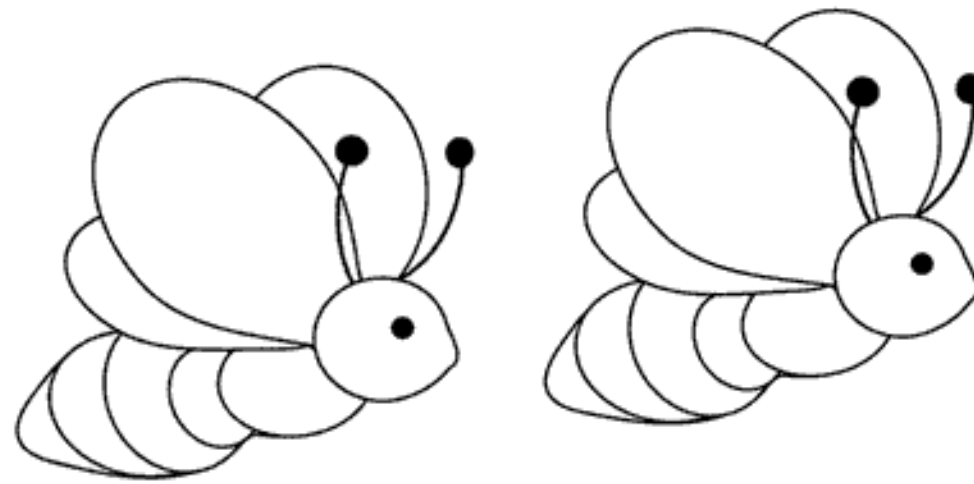

Nombre :

Curso :

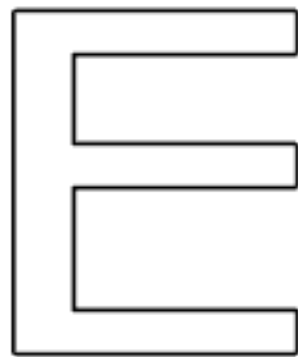
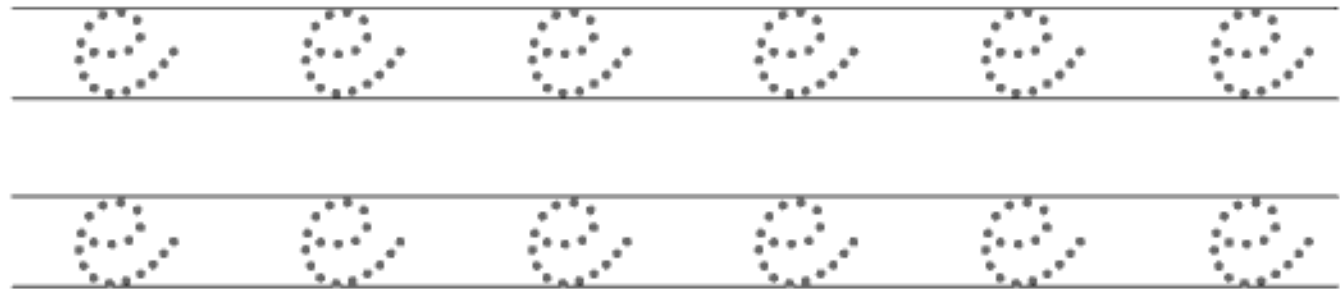
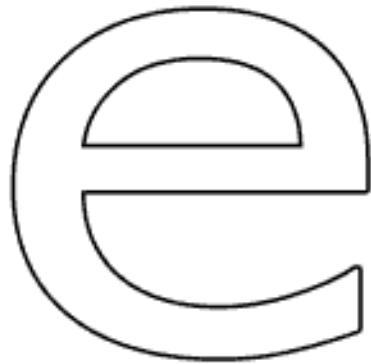
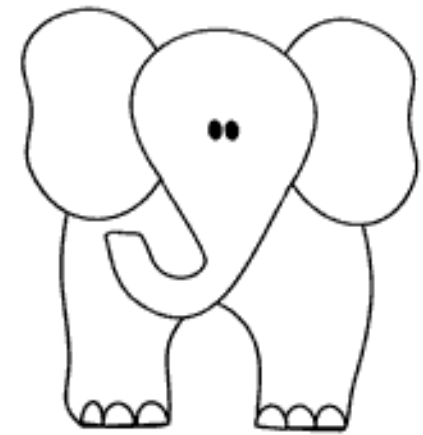
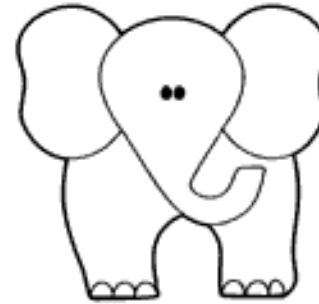
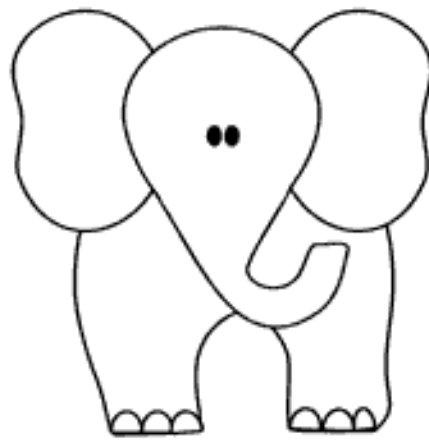

Nombre :

Curso :

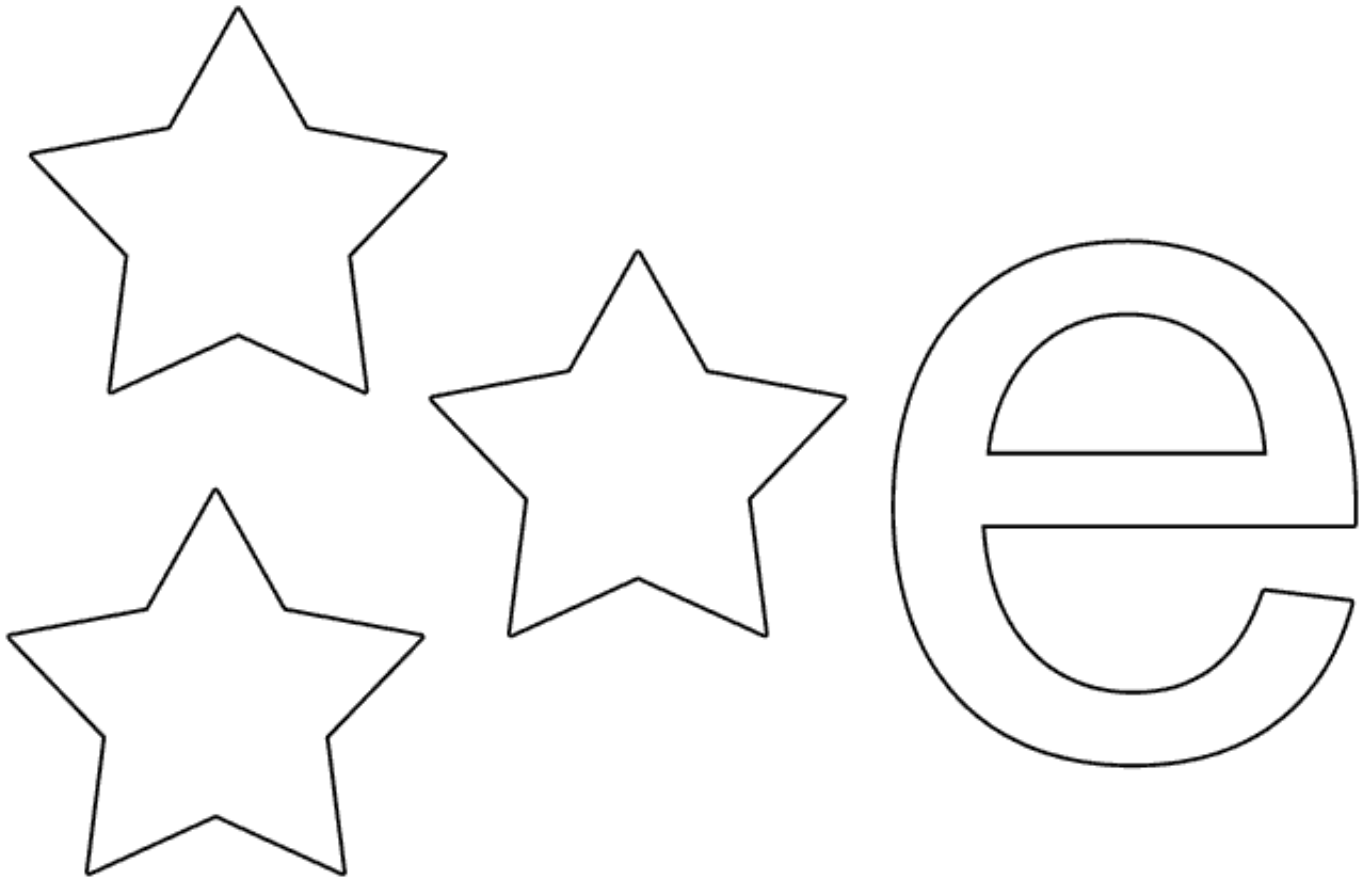

Nombre:

Curso:

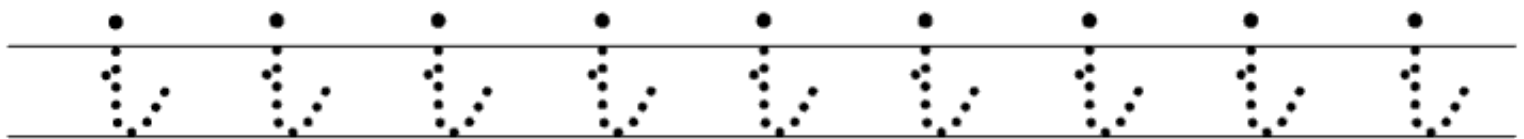
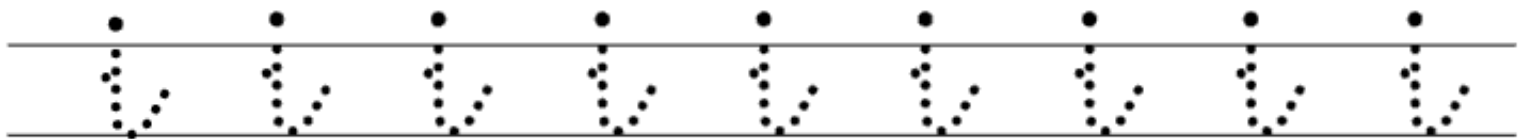
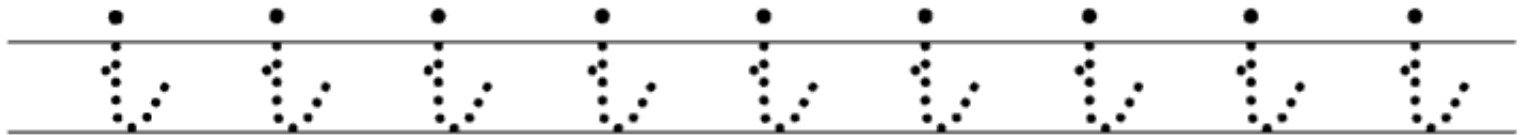
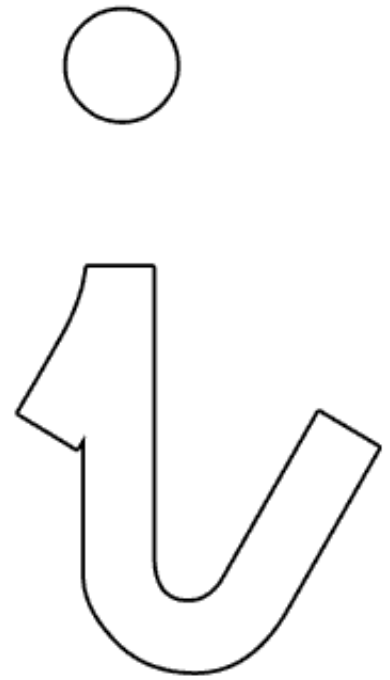
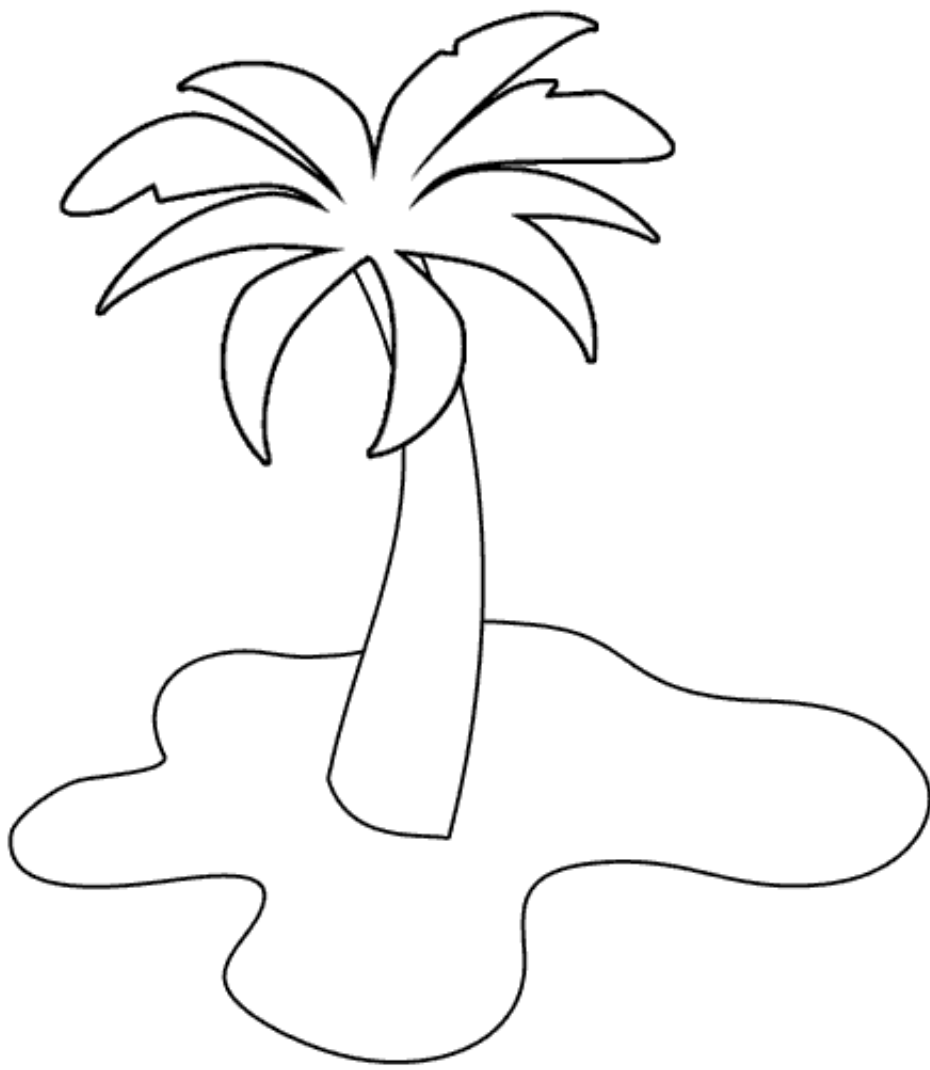

Nombre:

Curso:

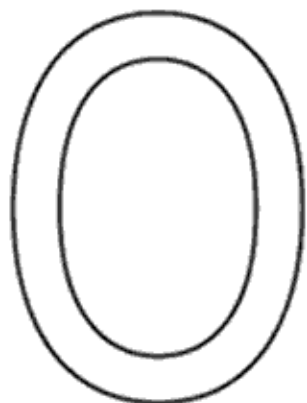
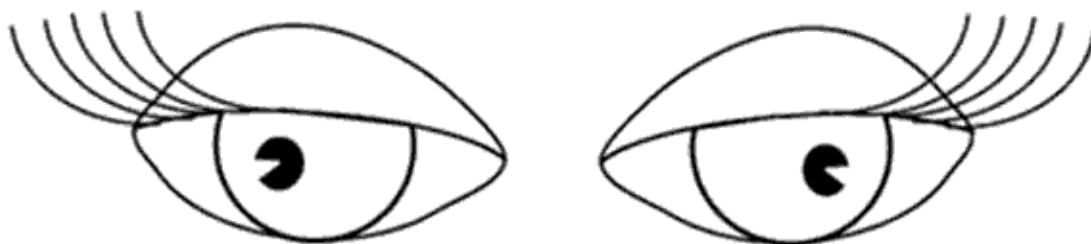

Nombre :

Curso :

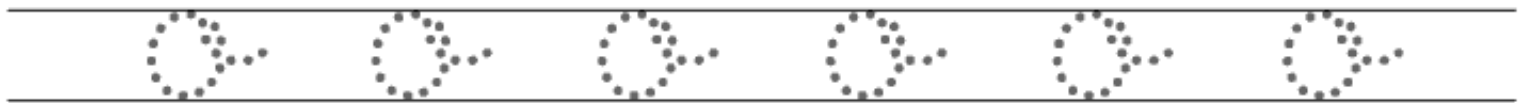
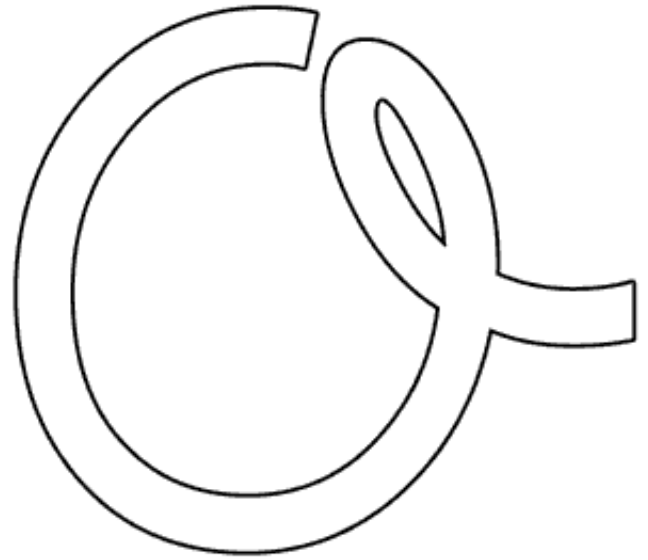
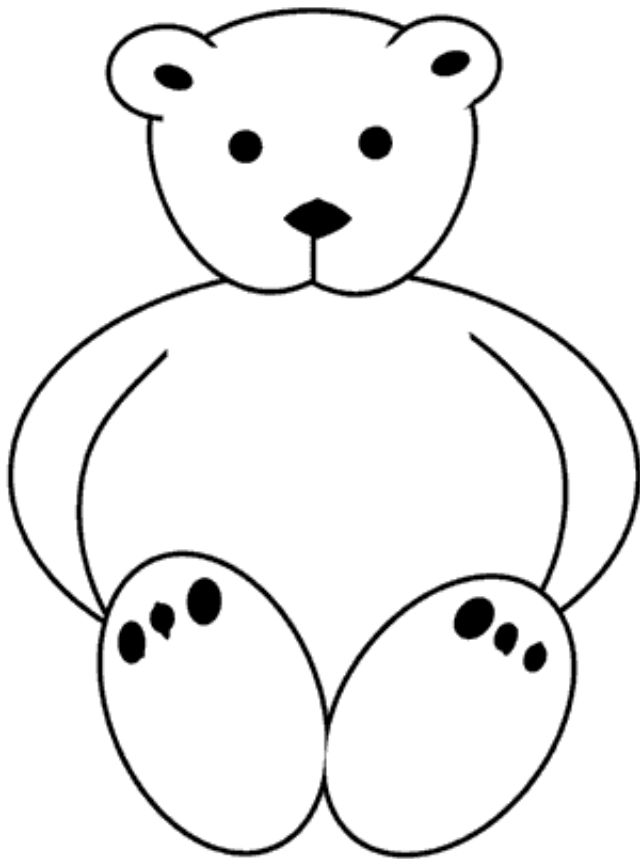

Nombre:

Curso:

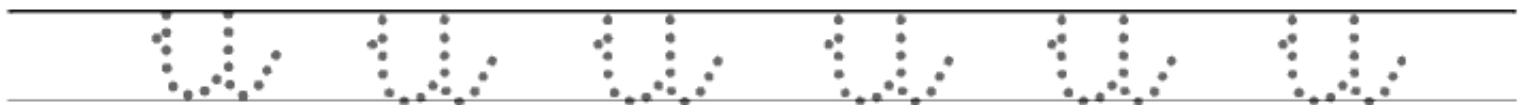
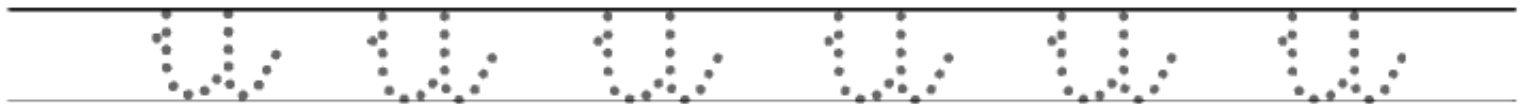
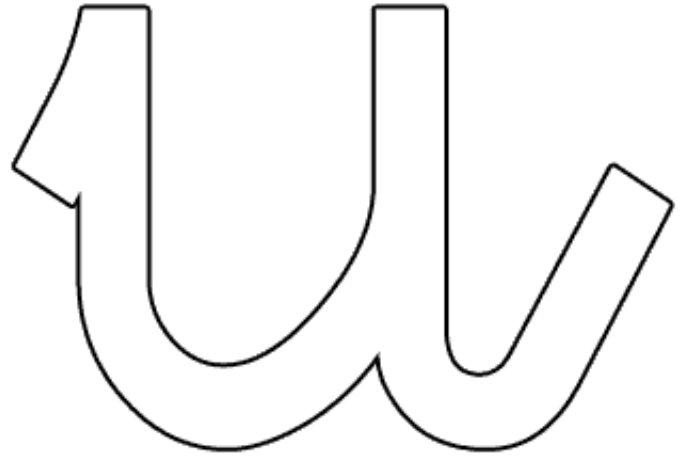
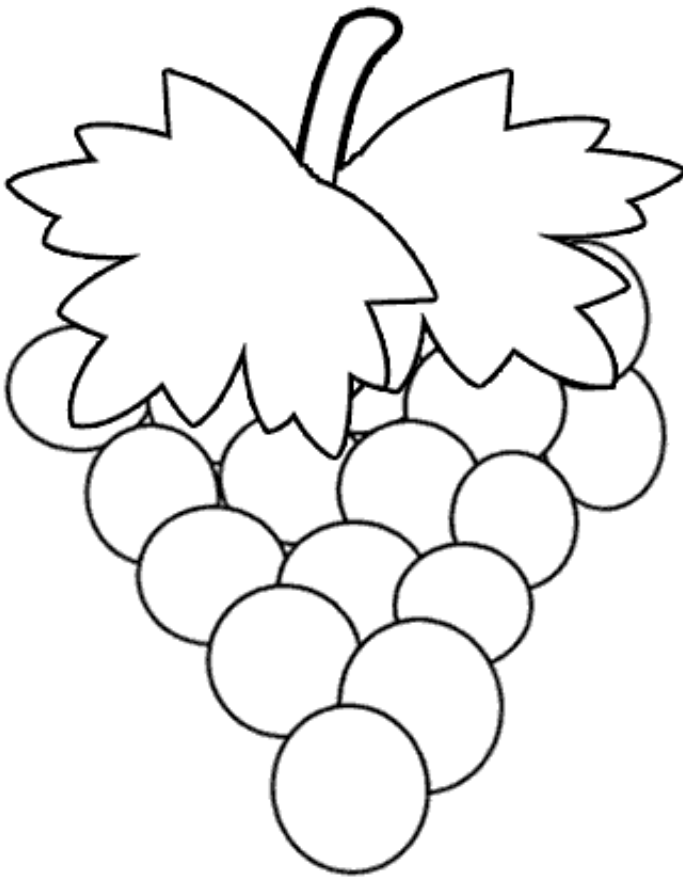

Nombre:

Curso:

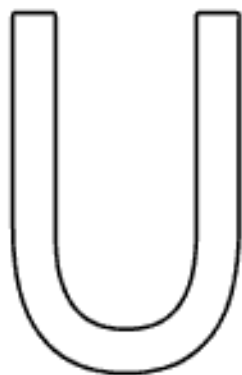

Nombre :

Curso :

b

b

b

b

b

b

b

b

b

b

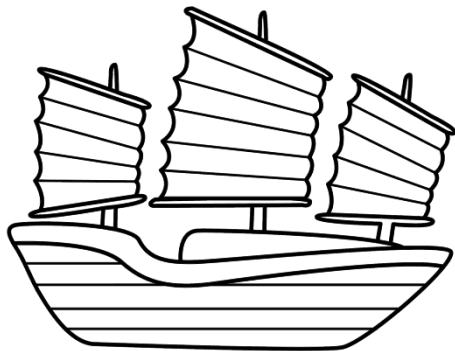

b

b

b

b

b

b

C



C



casa

C



d d d d d

d d d d d

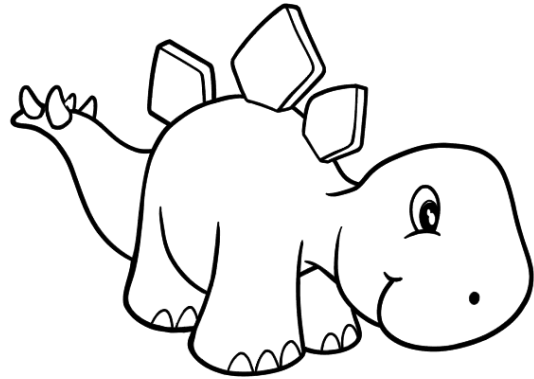

dinosaur

d d d d d

f f f f f

f f f f f

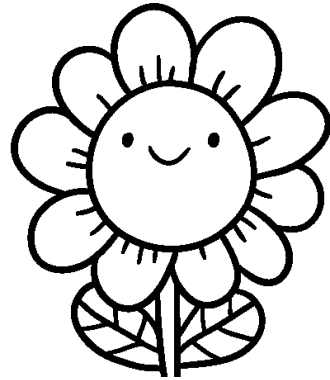

f f f f f

f f f f f

g g g g g

g g g g g

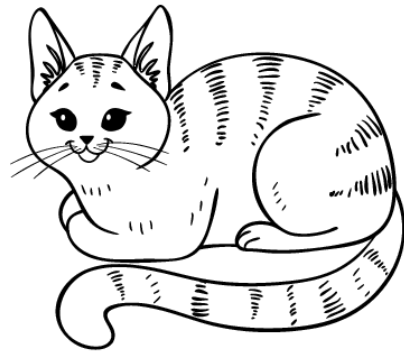

gato

g g g g g

h h h h h

h h h h h

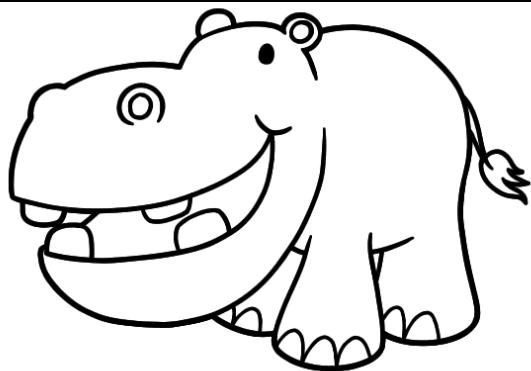

hipopotamo

h h h h h

j j j j j

j j j j j



j j j j j

j j j j j

k

k

k

k

k

k

k

k

k

k

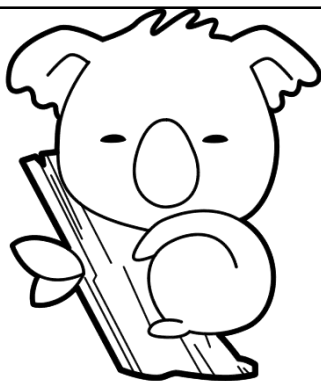

koala

k

k

k

k

k

l l l l l

l l l l l

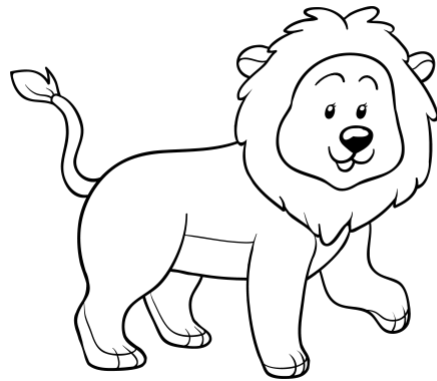

león

l l l l l

m m m m

m m m m

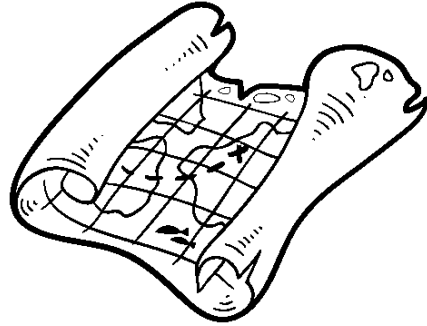

mama

m m m m

n n n n n

n n n n n

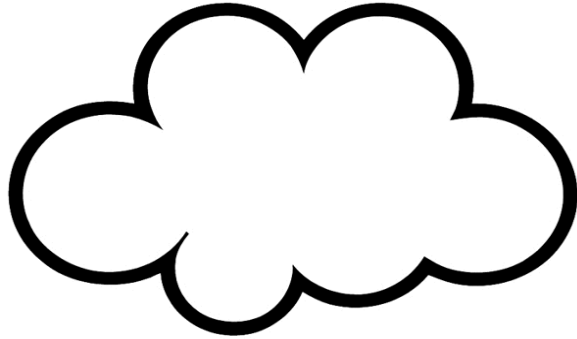

nube

n n n n n



Handwriting practice row 1: A solid cursive letter 'r' followed by four dotted cursive letters 'r' for tracing on a four-line grid.

Handwriting practice row 2: A solid cursive letter 'r' followed by four dotted cursive letters 'r' for tracing on a four-line grid.



Handwriting practice row 3: A blank four-line grid with the word 'piano' written in dotted cursive letters for tracing.

Handwriting practice row 4: A solid cursive letter 'r' followed by four dotted cursive letters 'r' for tracing on a four-line grid.

q q q q q

q q q q q

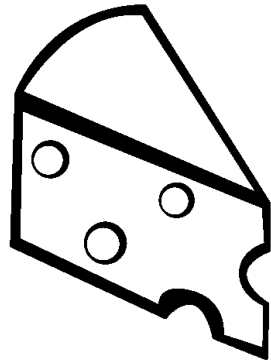

queso

q q q q q

~ ~ ~ ~ ~

~ ~ ~ ~ ~

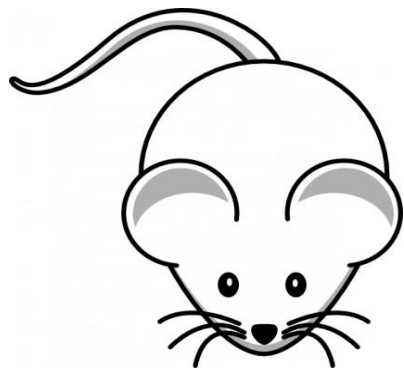

~
~
~

~ ~ ~ ~ ~

2

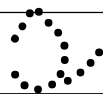
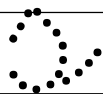
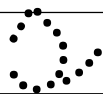
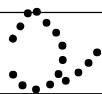

2

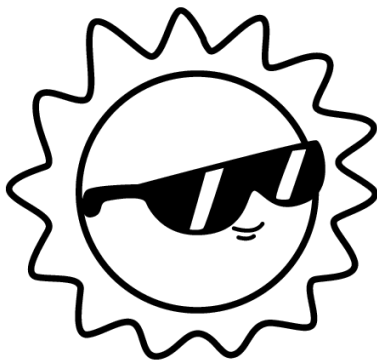
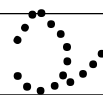
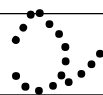
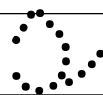
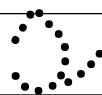

sol

2

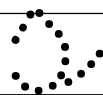
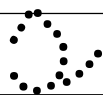
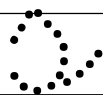
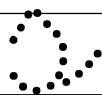

t

t

t

t

t

t

t

t

t

t

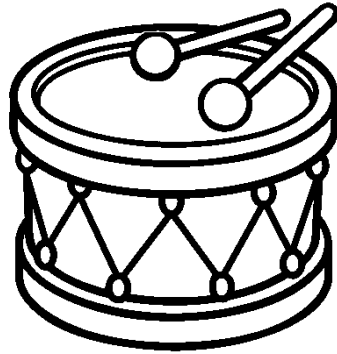

tambourine

t

t

t

t

t

v

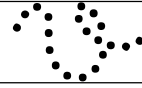
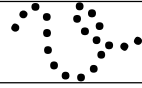
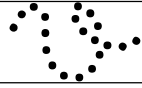
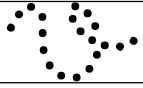

v

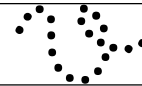
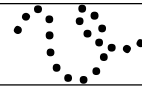
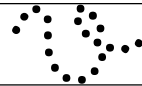
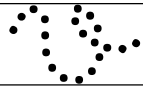

v

v

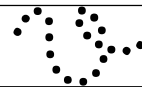
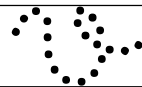
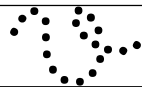
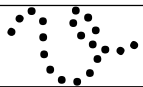

w w w w

w w w w



windsurf

w w w w

x

x

x

x

x

x

x

x

x

x

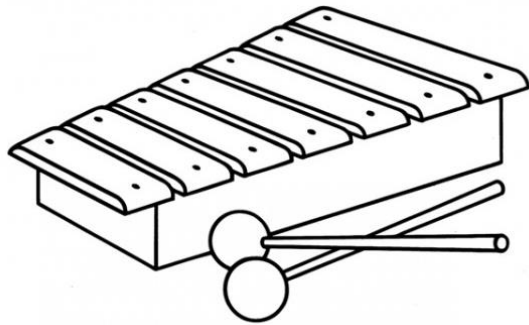

x

x

x

x

x

x

y y y y y

y y y y y



yoyo

y y y y y

Z z z z z

Z z z z z

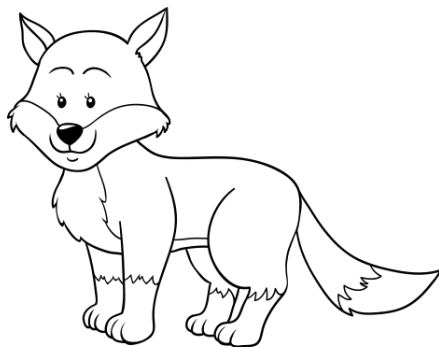

zozo

Z z z z z